

# The Finishing Touch

Dimensions Design Digital

## SmartParts Objects for ArchiCAD

### Table of Contents

<p><b>2 Introduction</b> Easy Installation Instructions Setting up Active Libraries</p> <p><b>3 Real Doors &amp; Windows</b> Door Objects Door Styles Bifold Door Styles Door Handle Styles</p> <p><b>4 Real Doors &amp; Windows</b> Window Objects</p> <p><b>5 Real Kitchen &amp; Bath</b> Kitchen Cabinets</p> <p><b>6 Real Kitchen &amp; Bath</b> Vanities Cabinet Door Styles Appliances</p> <p><b>7 Real Kitchen &amp; Bath</b> Plumbing: Sinks Plumbing: Toilets &amp; others Plumbing: Faucets &amp; handles Plumbing: Tubs &amp; Showers</p>	<p><b>8 Real Kitchen &amp; Bath</b> Kitchen Accessories Bathroom Accessories</p> <p><b>9 Real Store Planner</b> Display Racks Display Cabinets</p> <p><b>10 Real Store Planner</b> Slatwall System Gridwall System</p> <p><b>11 Real Store Planner</b> Standards &amp; Hangrod Brackets Glass Shelf System Lighting &amp; Accessories</p> <p><b>12 HOME Furniture</b> Seating Tables Bedroom Storage</p> <p><b>13 HOME Furniture</b> Outdoor Decor Dining Accessories Electronics</p>	<p><b>14 OFFICE Furniture</b> Desks Desktops Panels</p> <p><b>15 OFFICE Furniture</b> Storage Seating Desk Accessories</p> <p><b>16 TRIM Objects</b> Mouldings Stair parts Other Fine Details</p> <p><b>17 TRIM Objects</b> Trim Macro Objects</p>
--	---	--

Click on subject to go to there  
and the page number to Table of Contents

## DISCLAIMER

This software is distributed "as is." The author hereby disclaims all warranties relating to this software, whether express or implied, including without limitation any implied warranties of merchantability or fitness for a particular purpose. The author will not be liable for any special, incidental, consequential, indirect or similar damages due to loss of data or any other reason, even if advised of the possibility of such damages. The user of this software bears all risk as to its quality and performance.

## SOFTWARE PRODUCT LICENSE AGREEMENT

This Object Library package has a single user license and thus may be used on one computer at a time. For each additional computer, you must purchase an additional package or a site license. You are authorized to make archival copies of the software product for the sole purpose of backing up your software and protecting your investment from loss or damage. No other copies of the software may be produced for share or sale to third parties. Please respect and support third party development.

Be sure to register this software by either sending back the enclosed registration card, e-mail, or phone. This will enable you to receive notices about future updates and releases, plus provide us with ideas for better libraries.

DIMENSIONS Design Group, Inc. is committed to bring the highest quality to electronic media. Ideas and comments are always welcomed.

ArchiCAD and PlotMaker are registered trademarks of Graphisoft.

Macintosh and QuickTime are registered trademarks of Apple Computer, Inc..

MS-DOS and Windows are registered trademarks of Microsoft Corporation.

---

---

## Introduction

**SmartParts 3D Objects Collection** adds that extra touch of realism to ArchiCAD models. Included in this set are flexible, parametric wall opening objects that can be used for most common applications. To use you must install on your computer and register to get Code Key.

## Easy Installation Instructions

1. Insert the disc into your CD-ROM drive.
2. Double-click the D3 SmartParts icon to display the contents.
3. Double-click the Installer icon.
4. Follow the on-screen instructions.

---

## Setting up Active Libraries

### Active Libraries

To use the libraries, move the folders to the location of the **Active Library** (by default **ArchiCAD Library**).

TIP - Create a separate folder as your special add-on and custom objects. This way if you leave the ArchiCAD Library intact, upgrading is easier. Use the menu **File/Load Libraries** to add your special folder to your projects. If you make your own unique custom objects for a project, a project folder for each project can reduce the loading time.

To ensure that the libraries get properly loaded, make sure that ArchiCAD is not currently running.

## Upgrading and Archiving

If you are using a previous version of SmartParts, it is a good idea to make an **Archive** file of it to store the exact set of objects and names associated to that particular project. Otherwise since some of the objects have had their parameters switched to coordinate with all other objects, you may find abnormalities in parts. If this happens select the object and change the appropriate parameters.

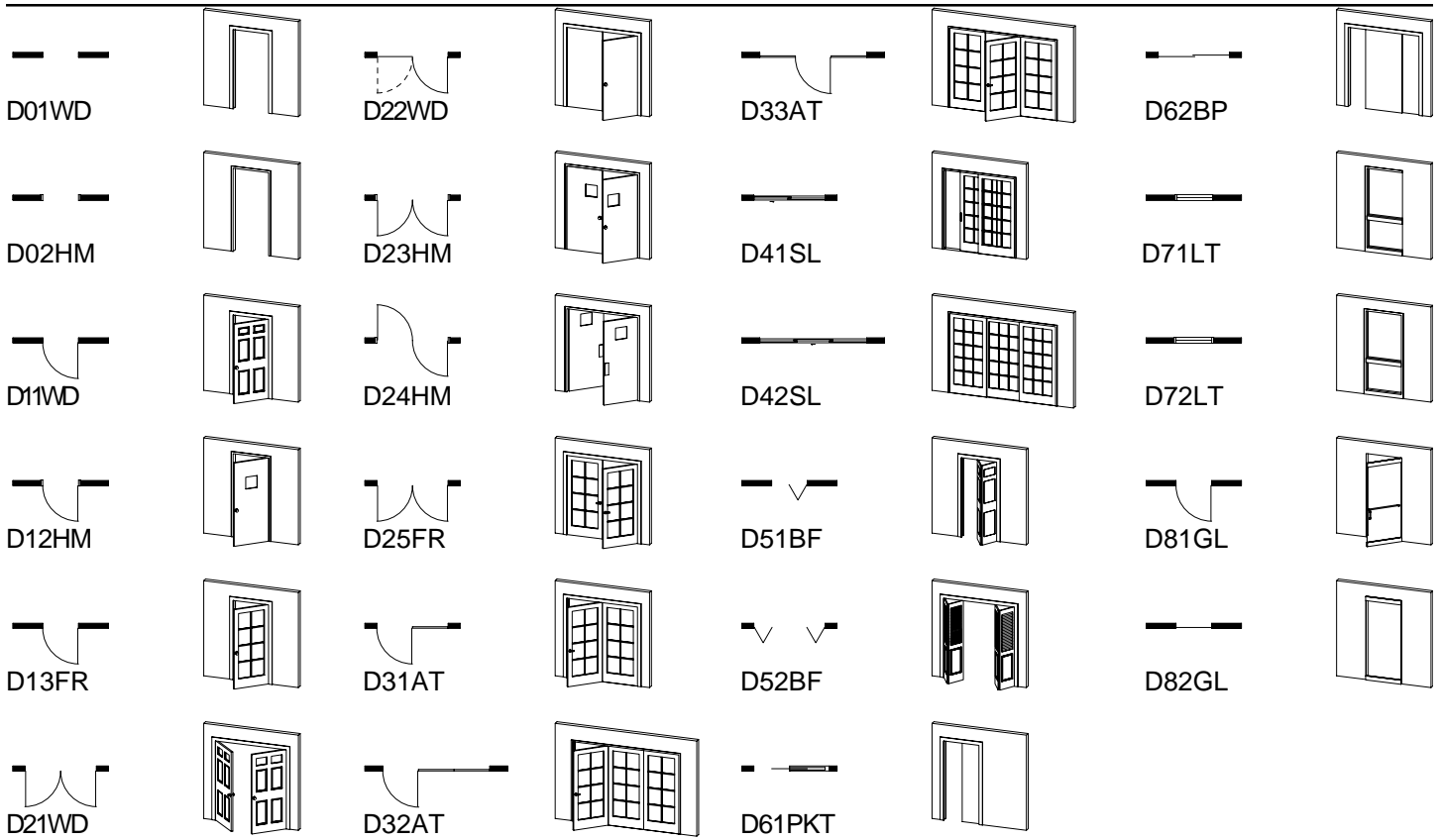

**Real Doors & Windows Objects for ArchiCAD**

D<sup>3</sup> SmartParts™ © 1998 DIMENSIONS Design Group, Inc.

**Door Panel Styles**

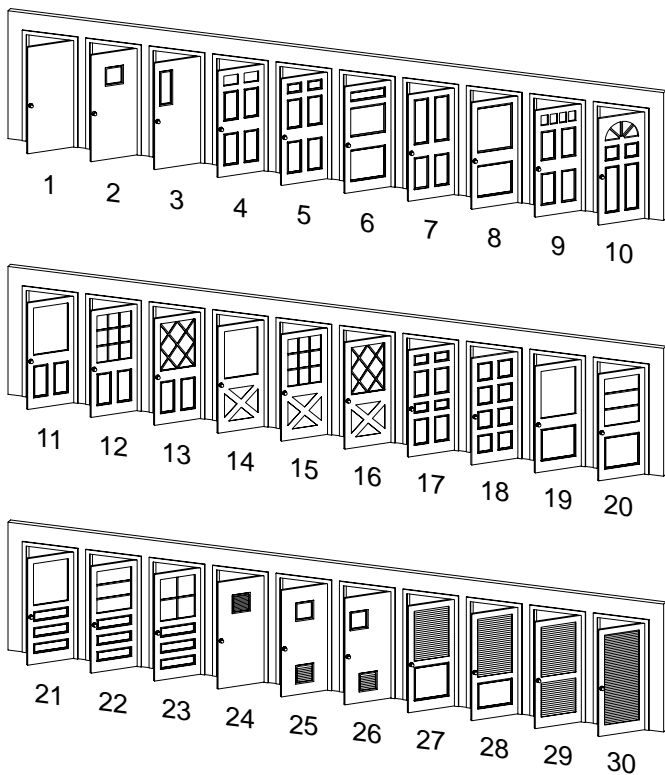

**Door Styles B - Bifold**

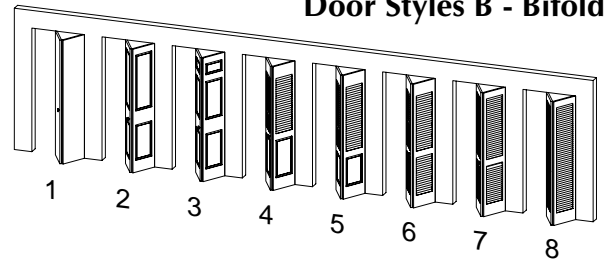

**Door Handle Styles A**

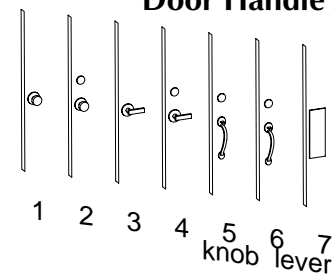

**Door Handle Styles B**

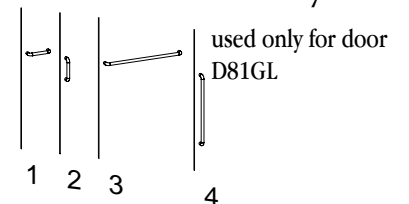

W10FIX		W31DH		W41RT		W53RQ	
W11AWN		W32DH		W42EQT		W91COM	
W12HOP		W33DH		W43Trp		W92COM	
W21CAS		W34DHP		W44EQG			
W22CAS		W35HSL		W51RF			
W29TRIM		W39TRIM		W52RH			

**Real Doors & Windows Objects for ArchiCAD**

D<sup>3</sup> SmartParts™ © 1998 DIMENSIONS Design Group, Inc.



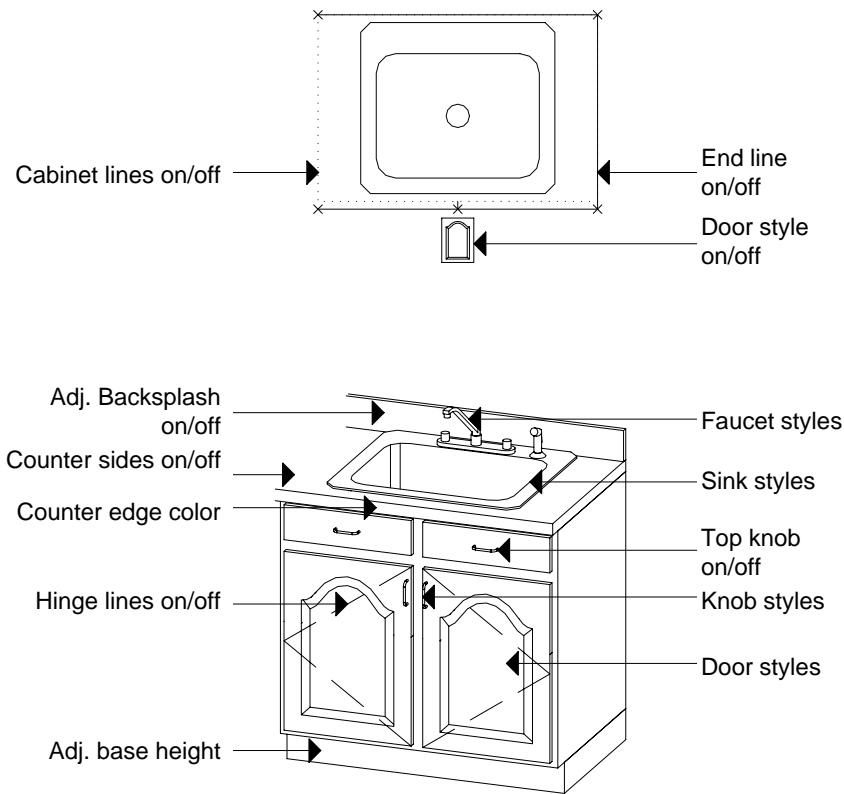





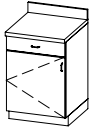
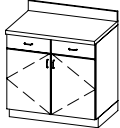

## Anatomy of a Cabinet

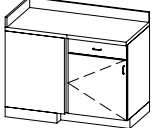

## Real Kitchen & Bath Objects for ArchiCAD

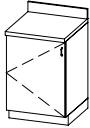
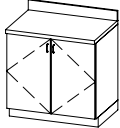
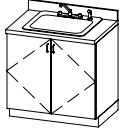
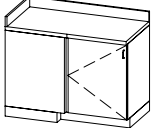

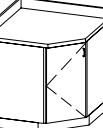
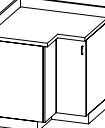





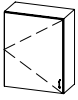
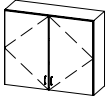
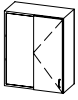
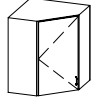

D<sup>3</sup> SmartParts™ © 1998 DIMENSIONS Design Group, Inc.

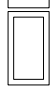
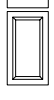
## Kitchen Cabinets

 B09 B12 B15 B18 B21 B24	 B27 B45 B30 B48 B33 B36 B39 B42	 BS30 BS36 BS42 BS42D3 BS48 BS42D3	 BC30 BC36 BC42 BC48	 BD309 BD312 BD315 BD318 BD321 BD324	 BD409 BD412 BD415 BD418 BD421 BD424	 BD509 BD512 BD515 BD518 BD521 BD524	
 B09F B12F B15F B18F B21F B24F	 B27F B45F B30F B48F B33F B36F B39F B42F	 BS30F BS36F BS42F BS42D3 BS48F BS48D3	 BC30F BC36F BC42F BC48F	 BCA36	 BCA36F	 BLS36	 DESK36

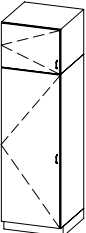
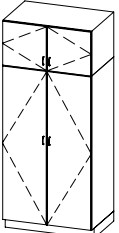
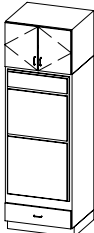
## Kitchen Cabinets

## Cabinet Door Styles











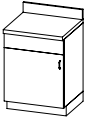
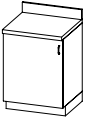
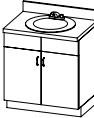
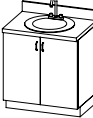
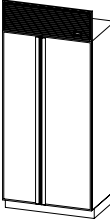
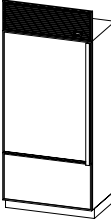
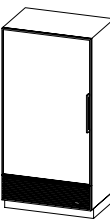
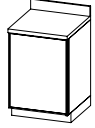

							
W0930 W1230 W1530 W1830 W2130 W2430	W2730 W4530 W3030 W4830 W3330 W3630 W3930 W4230	WBC2130 WBC2430 WBC2730 WBC3030 WBC3330 WBC3630	WCA2430	cabdr01	cabdr02	cabdr03	cabdr04
							
				cabdr05	cabdr06	cabdr07	cabdr08
							
BRB2424 BRW2412	BRB3624 BRW3612	O27Oven		cabknob1	cabknob2	cabknob3	cabknob4

## Real Kitchen & Bath Objects for ArchiCAD

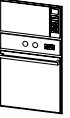
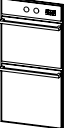
D<sup>3</sup> SmartParts™ © 1998 DIMENSIONS Design Group, Inc.













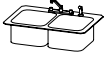











## Vanities

## Appliances

							
V09 V12 V15 V18 V21	V09F V12F V15F V18F V21F	VS30 VS36	VS30F VS36F	Subzero1	Subzero2	Subzero3	uc_refr
							
VD312 VD315	VD412 VD415	VD512 VD515	VSMULTI Any number of sinks and	oven1	oven2	oven3	dishwash
							
				trashcmp	icemaker	ranghood	microwav

**Plumbing: Sinks**

**Plumbing: Faucets & Handles**













Kitchen sink 	Kitchen sink 	Kitchen sink 	Kitchen sink 				
Ksink01	Ksink02	Ksink03	Ksink04	faucet01	faucet02	faucet03	faucet04
Kitchen sink 	LavWall 	LavHC 					
Vanity sink	Vanity sink	Vanity sink	Vanity sink	faucet05	faucet06	faucet07	faucet08
LavRnd1 	LavOvl1 	LavRnd2 	LavOvl2 	Fknob01 	Fknob02 	Fknob03 	Fknob04 
				Fknob05 User definable 	Fknob06 User definable 		

**Real Kitchen & Bath Objects for ArchiCAD**

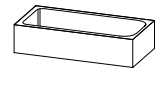
D<sup>3</sup> SmartParts™ © 1998 DIMENSIONS Design Group, Inc.

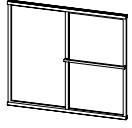

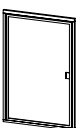
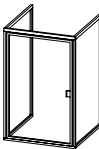







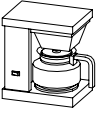

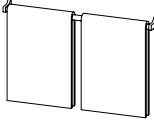
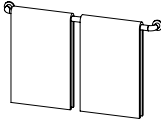
**Plumbing: Toilets & others**

**Plumbing: Tubs & Showers**

							
toilet01	toilet02	toilet03	bidet01	tub_whrl	tub_oval	tub_reg	
							
urinal01				Shrcurt	Shrdr4	Shrbase1	Shrbase2
							
					Shrdr1	Shrdr2	Shrdr3

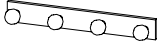

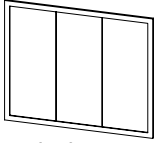

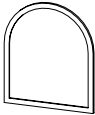
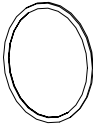

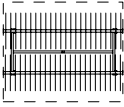
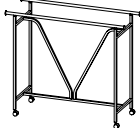

**Kitchen Accessories**

**Bathroom Accessories**

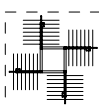
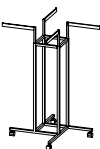
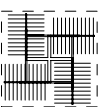
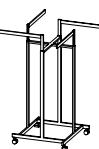
							
coffee1	blender	toaster1		towlbar1	towlbar2	grabbar1	
							
wine_bot	wine_gs			TPdisp1	TPdisp2		
							
				Lites_hr	Lites_vt	medcab1	
							
				mirror1	mirror2	mirror3	



## Display Racks

 		 	
Double Rail Rack 60" - Dbrail60		Round Rack 36" - round36 Round Rack 30" - round30	
 		 	
Four-way Rack - Fourway		Super Quad Rack - Supquad	
 		Clothes can be displayed as single items or turned on in any rack or display arm by choosing 1 thru 4 options	
Two-way Rack - Twoway			
			
option 1 shirt2	option 2 jacket2	option 3 dress2	option 4 pants2







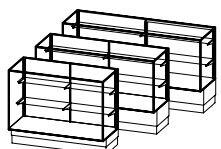
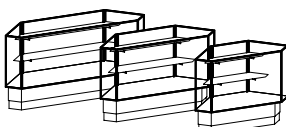
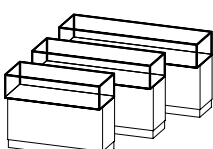
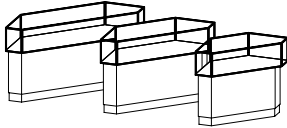
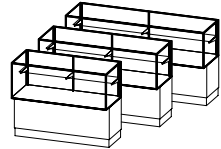
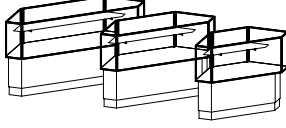
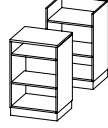
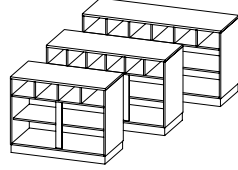



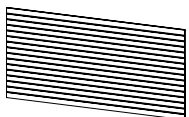





## Real Store Planner Objects for ArchiCAD

D<sup>3</sup> SmartParts™ © 1998 DIMENSIONS Design Group, Inc.

## Display Cabinets

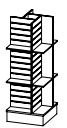
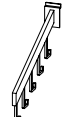
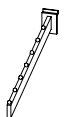
			
FullVis - Full Vision Display Cases FDisp48, FDisp60, FDisp70	FullVis - Full Vision Display Cases FDispC34, FDispC42, FDispC51	Jewelry - Jewelry Display Cases JDisp48, JDisp60, JDisp70	Jewelry - Jewelry Display Cases JDispC34, JDispC42, JDispC51
			
HalfVis - Half Vision Display Cases HDisp48, HDisp60, HDisp70	HalfVis - Half Vision Display Cases HDispC34, HDispC42, HDispC51	Counter - Register stands Reg24T, Reg24W	Counter - Cashwrap counters Wrap48, Wrap60, Wrap70



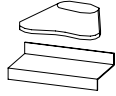







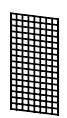

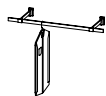





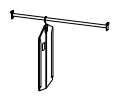
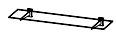

## Slatwall System

 SLATWALL				 SLFO16 Faceout 16"	 SLFO12 Faceout 12"	 SLN3 Single notch 3"	 SLPO12 Postout 12"
 SLSH1236 Shelf w/ brackets	 SLshelf Shelf	 SLHR336 Hangrod 3" set	 SLHR1436 Hangrod 14" set	 SLH10 Hook 10"	 SLH8 Hook 8"	 SLH6 Hook 6"	 SLH4 Hook 4"
 SLATSHLF1				 SLHK15 Hook Waterfall	 SLWF16 7 Ball Waterfall	 SLWF12 5 Ball Waterfall	 SLSH12 Shelf bracket
				 SLHR14 Hangrail 14"	 SLHR3 Hangrail 3"	 SHOESHLF Shoe shelf	

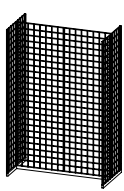
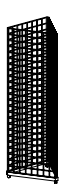
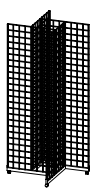
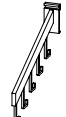
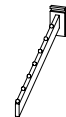













## Real Store Planner Objects for ArchiCAD

D<sup>3</sup> SmartParts™ © 1998 DIMENSIONS Design Group, Inc.

## Gridwall System

 gridwall	 gridsup	 GRHR1436 Hangrod 14" set	 GRHR336 Hangrod 3" set	 GRFO16 Faceout 16"	 GRFO12 Faceout 12"	 GRN3 Single notch 3"	 GRPO12 Postout 12"
 GRHROD Hangrod	 GRSH1236 Shelf w/ brackets	 GRshelf Shelf		 GRH10 Hook 10"	 GRH8 Hook 8"	 GRH6 Hook 6"	 GRH4 Hook 4"
 grtower1	 grtower2	 grtower3		 GRHK15 Hook Waterfall	 GRWF16 7 Ball Waterfall	 GRWF12 5 Ball Waterfall	 GRSH12 Shelf bracket
				 GRHR14 Hangrail 14"	 GRHR3 Hangrail 3"	 gridsup Grid support	

## Standards & Hangrod Brackets



 STSH1236 Shelf w/ brackets	 Shelf	 STHR336 Hangrod 3" set	 STHR1436 Hangrod 14" set	 Standrd1 Single slot	 Standrd2 Double slot	 HRFO16 Faceout 16"	 HRFO12 Faceout 12"
 Rectube Rectangular tube							
				 HRHK15 Hook Waterfall	 HRWF16 7 Ball Waterfall	 HRWF12 5 Ball Waterfall	 STSH12 Shelf bracket
				 HR14 Hangrail 14"	 HR3 Hangrail 3"		

## Real Store Planner Objects for ArchiCAD

D<sup>3</sup> SmartParts™ © 1998 DIMENSIONS Design Group, Inc.

## Glass Shelf System

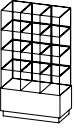
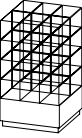
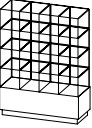
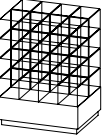

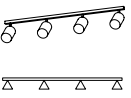
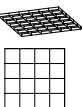
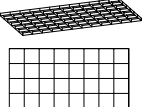
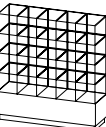
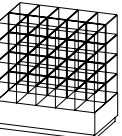

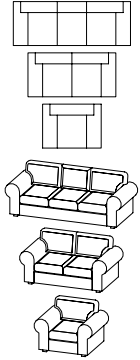
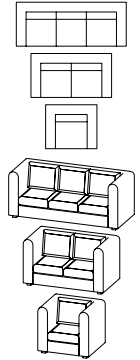
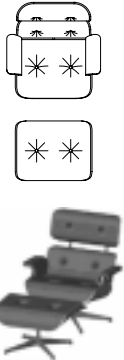
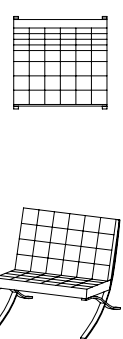
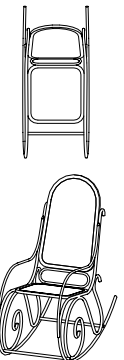
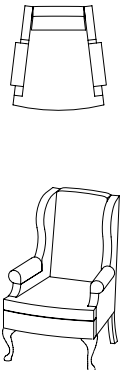
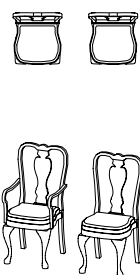
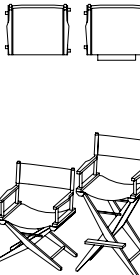
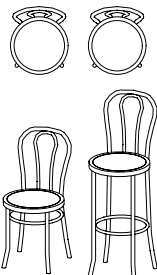
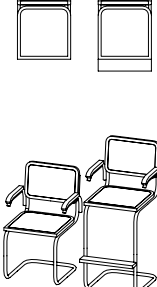
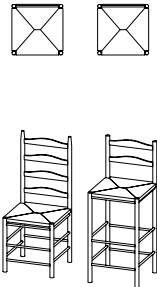
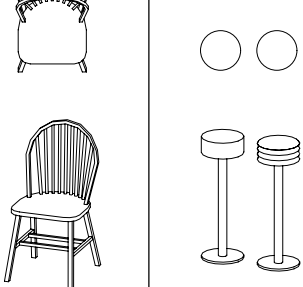
## Lighting & Accessories

 GLSH3S Glass shelf 3 wide single deep	 GLSH3D Glass shelf 3 wide double deep	 GLSH4S Glass shelf 4 wide single deep	 GLSH4D Glass shelf 4 wide double deep	 Folded Stacking clothes			
				 TrakLite Track Lights	 2x2para Parabolic lens	 2x4para Parabolic lens	
 GLSH5S Glass shelf 5 wide single deep	 GLSH5D Glass shelf 5 wide double deep						

 <p>chair1, luvseat1, couch1</p>	 <p>chair2, luvseat2, couch2</p>	 <p>Eames_lg Eames_ot</p>	 <p>Barcelon</p>	 <p>rocker1  rocker2</p>	 <p>wing_chr</p>
 <p>Qann_chr</p>	 <p>dirc_chr dirc_stl</p>	 <p>cafe_chr cafe_stl</p>	 <p>brur_chr brur_stl</p>	 <p>ladr_chr ladr_stl</p>	 <p>Windsor  bar_stl1</p>

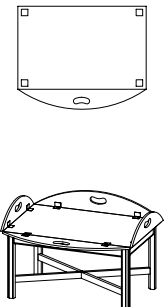
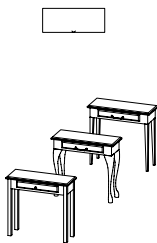
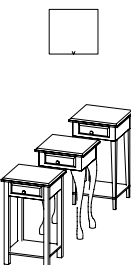
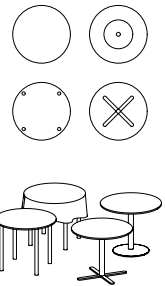
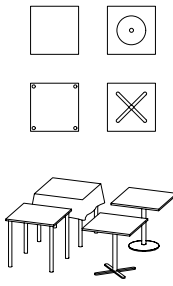

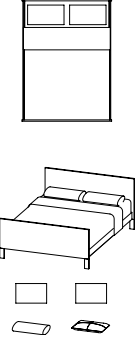
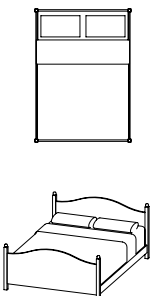
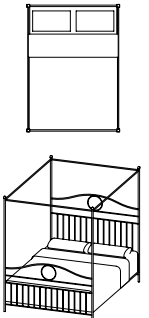
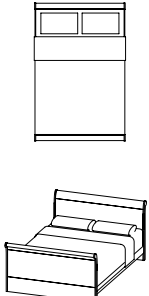

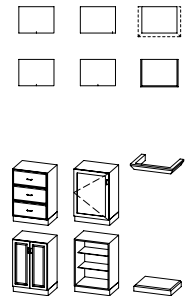
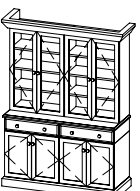





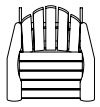

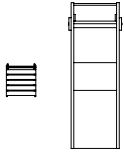
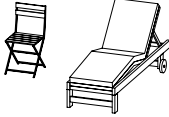
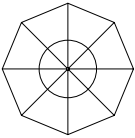



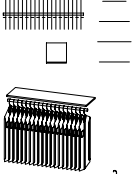

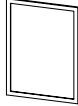

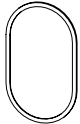

**HOME Furniture Objects for ArchiCAD**

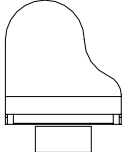
D<sup>3</sup> SmartParts™ © 1998 DIMENSIONS Design Group, Inc.

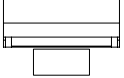
 <p>butlertbl</p>	 <p>hall_tbl</p>	 <p>side_tbl</p>	 <p>tbl_rnd1, tbl_rnd2, tclothrd</p>	 <p>tbl_sqr1, tbl_sqr2, tclthsq</p>	 <p>tbl_oval, tclothov</p>	 <p>bed1king, bed1quen, bed1full, bed1twin, pillow1</p>
 <p>bed2king, bed2quen, bed2full, bed2twin</p>	 <p>bed3king, bed3quen, bed3full, bed3twin</p>	 <p>bed4king, bed4quen, bed4full, bed4twin</p>	 <p>dresser1, dresser2</p>	 <p>dresser3</p>	 <p>stordwr, stordor1, stordor2, storshf, stor_cap, storbase</p>	 <p>example of using storage components to create a china cabinet</p>

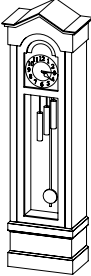

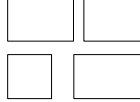
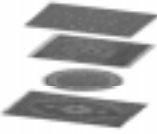





**HOME Furniture Objects for ArchiCAD**

D<sup>3</sup> SmartParts™ © 1998 DIMENSIONS Design Group, Inc.

 	 	 	 	 	  	  
Adirondk	patiochr patioicl	patiotbl umbrella	BBQgrill	rod_shlf, shirt1, jacket2, dress3, pants4, folded, shoe	mirror01, mirror02	mirror03, mirror04
 	 	 	 	 	 	 
curtain1	piano1 pi_bench	piano2	flrclock	mantclk, wallclk	rug01, rug02, rug03, rug04	wallpic1 wallpic2

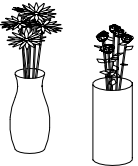
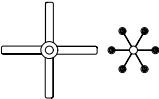
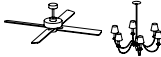

**HOME Furniture Objects for ArchiCAD**

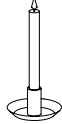
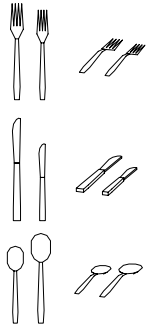
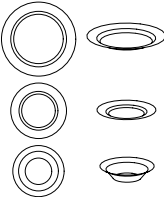
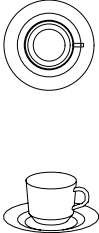
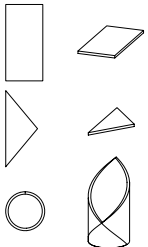
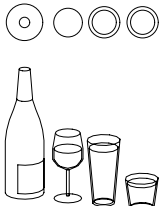
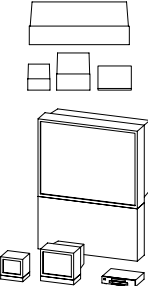
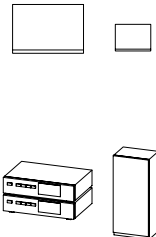
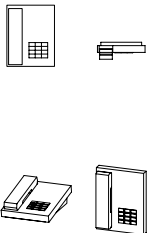
D<sup>3</sup> SmartParts™ © 1998 DIMENSIONS Design Group, Inc.

 	 	 	 	 	 	
pot01, pot02, pot03	plant01, plant02, plant03	vase01, vase02 daisy, rose	clg_fan, chandlr	cabriole	candle1	fork1, fork2 knife1, knife2 spoon1, spoon2
						
plate1, plate2, bowl	cup1, saucer	napkin1, napkin2, napkin3	btl_wine, gls_wine gls_tall, gls_shrt	TV1, TV2, TV3, VCR	Hi-Fi, speaker	phone1, phone2

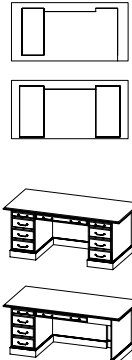
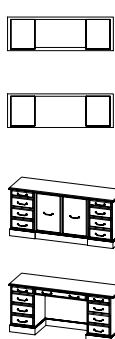
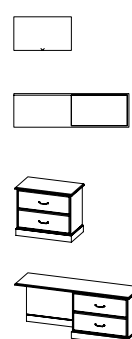
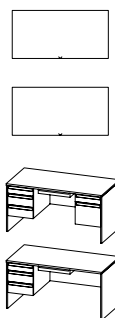
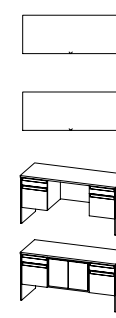

**HOME Furniture Objects for ArchiCAD**

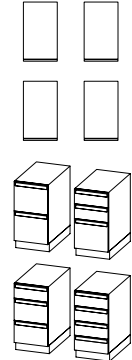
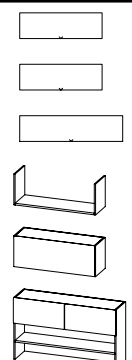
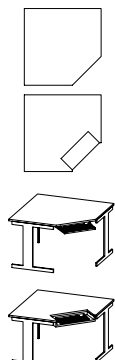
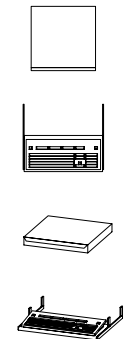
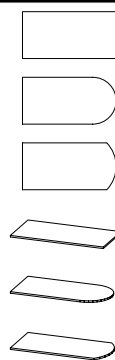
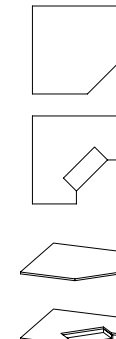
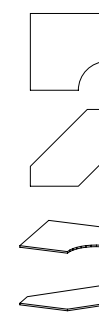
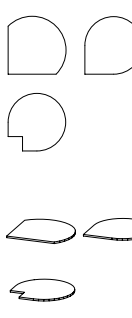
D<sup>3</sup> SmartParts™ © 1998 DIMENSIONS Design Group, Inc.

 <p>desk01, desk02</p>	 <p>credenz1, credenz2</p>	 <p>excfile1, excfile2</p>	 <p>desk03, desk04</p>	 <p>credenz3, credenz4</p>	 <p>return1, return2, bridge1</p>	 <p>pedestl1, pedestl2, pedestl3, pedestl4</p>
 <p>shelf1, shelf2, shelf3</p>	 <p>corner01, corner02</p>	 <p>drawer1, kybdtray</p>	 <p>top01, top02, top03</p>	 <p>top04, top05</p>	 <p>top06, top07</p>	 <p>top08, top09, top10</p>

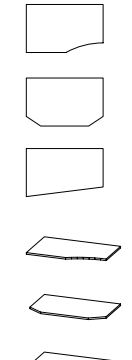
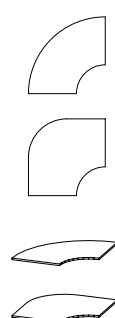
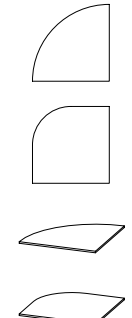
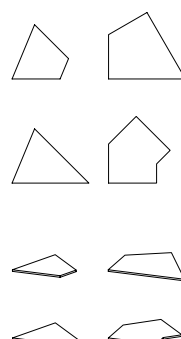
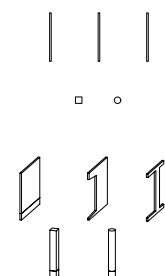
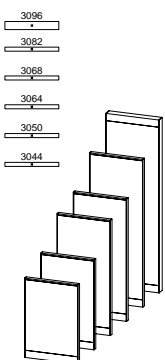
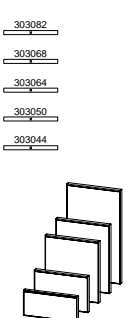

**OFFICE Furniture Objects for ArchiCAD**

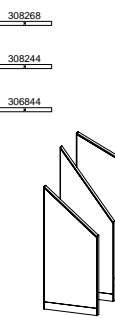
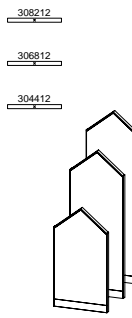
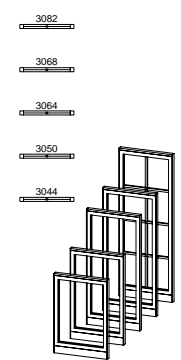
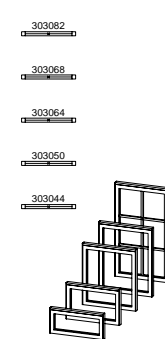
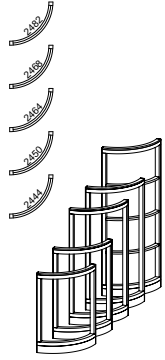
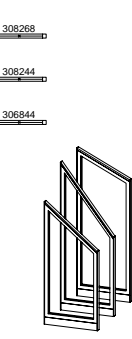
D<sup>3</sup> SmartParts™ © 1998 DIMENSIONS Design Group, Inc.

 <p>top11, top12, top13</p>	 <p>top14, top15</p>	 <p>top16, top17</p>	 <p>top18, top19, top20, top21</p>	 <p>top_end1, top_end2, top_end3, top_leg1, top_leg2</p>	 <p>panel01a</p>	 <p>panel01b</p>
 <p>panel01c</p>	 <p>panel01d</p>	 <p>panel01e</p>	 <p>panel02a</p>	 <p>panel02b</p>	 <p>panel02c</p>	 <p>panel02d</p>



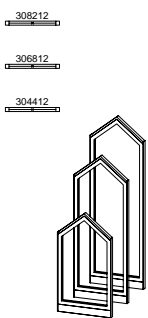
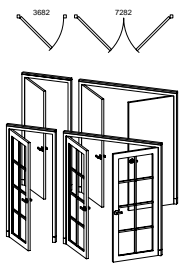
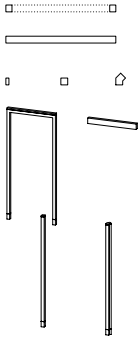
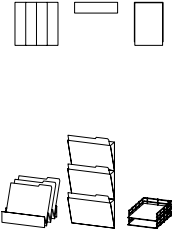
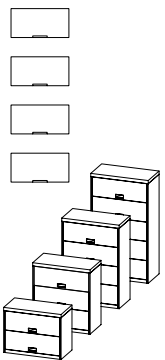
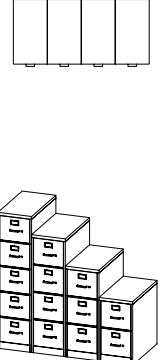
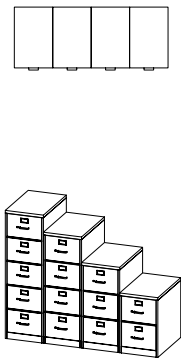
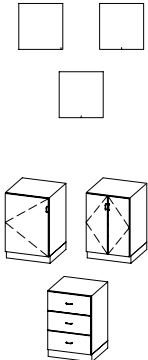
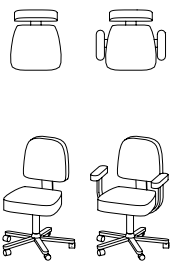
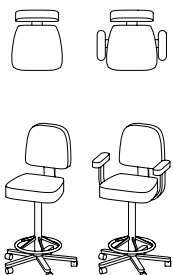

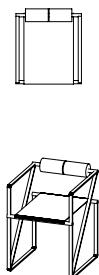
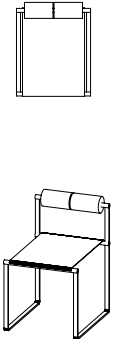



**OFFICE Furniture Objects for ArchiCAD**

D<sup>3</sup> SmartParts™ © 1998 DIMENSIONS Design Group, Inc.

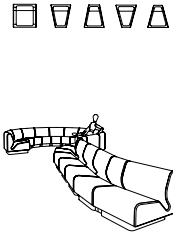
 <p>panel02e</p>	 <p>pnl_dr1, pnl_dr2</p>	 <p>pnl_opng, pnl_beam, pnl_end, pnl_jnt1, pnl_jnt2</p>	 <p>ppr_rak1, ppr_rak2, ppr_tray</p>	 <p>filelat2, filelat3, filelat4, filelat5</p>	 <p>filelet2, filelet3, filelet4, filelet5,</p>	 <p>fileleg2, fileleg3, fileleg4, fileleg5</p>
 <p>storage1, storage2, storage3</p>	 <p>taskchr1 taskchr2</p>	 <p>stool01 stool02</p>	 <p>exc-chr1</p>	 <p>exc-chr2</p>	 <p>Prima</p>	 <p>Seconda</p>

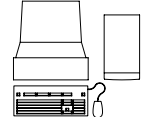

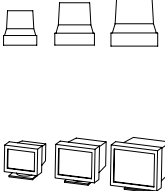
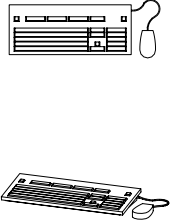
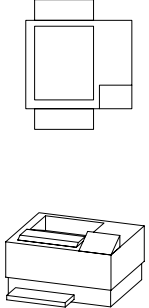
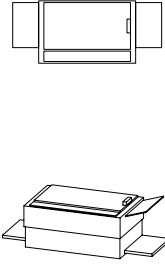

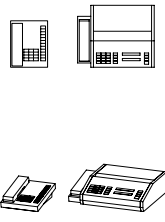
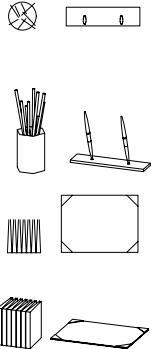

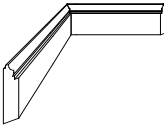
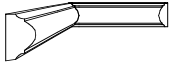
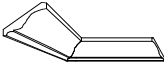

**OFFICE Furniture Objects for ArchiCAD**

D<sup>3</sup> SmartParts™ © 1998 DIMENSIONS Design Group, Inc.

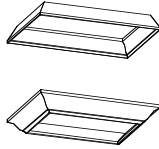
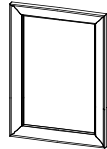
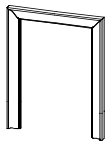
 <p>sidechr1</p>	 <p>sidechr2</p>	 <p>Chadst Chad22i, Chad22o Chad30i, Chad30o</p>	 <p>computr1</p>	 <p>computr2</p>	 <p>computr3</p>	 <p>laptop</p>
 <p>monitor1, monitor2, monitor3</p>	 <p>keyboard mouse</p>	 <p>laserprt</p>	 <p>copier</p>	 <p>scanner</p>	 <p>phone3, fax</p>	 <p>pen_cup, pen_set, notebook, writepad</p>

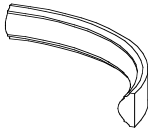
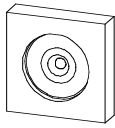
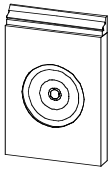
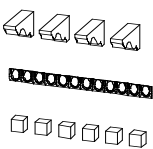
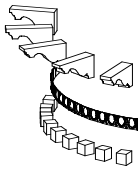
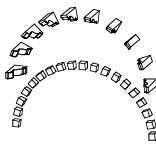
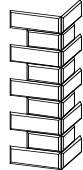

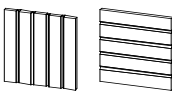
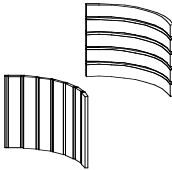
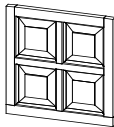

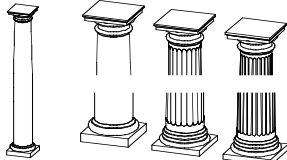



**OFFICE Furniture Objects for ArchiCAD**

D<sup>3</sup> SmartParts™ © 1998 DIMENSIONS Design Group, Inc.

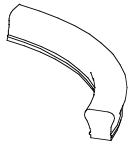
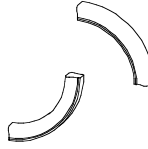
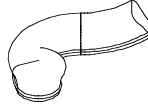
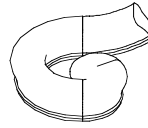
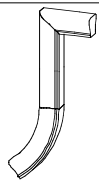
 <b>Trim Mouldings</b>							
	Trim base	Trim chair	Trim crown	Trim vertical	Trim 4-way	Trim frame 4	Trim frame 3
							
	Trim curve	Rosette	Plinth	Dentil straight	Dentil curve	Dentil arch	Trim quoins
 <b>Other Fine Details</b>							
	Bracket	Panel S1	Panel C1	Panel S2	Post turned	Post square	
							
Column classic							

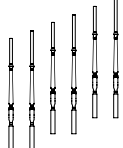
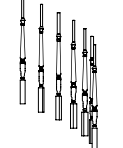
**TRIM Objects for ArchiCAD**

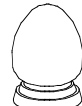
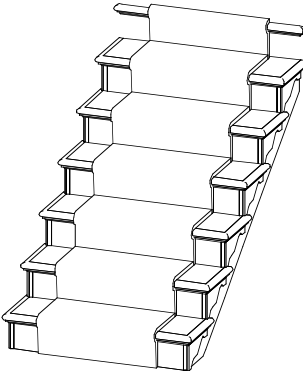
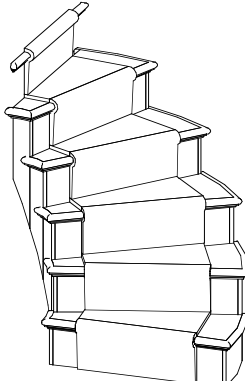
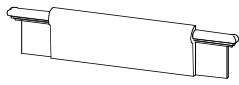

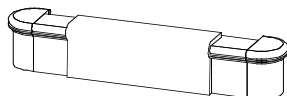
D<sup>3</sup> SmartParts™ © 1998 DIMENSIONS Design Group, Inc.

 <b>Stair Parts</b>							
	Rail straight	Rail vertical	Rail curve H	Rail curve V	Volute 1	Volute 2	Gooseneck
							
Baluster 1	Balustrade S1	Balustrade S2	Balustrade C1	Balustrade C2			
							
Newel cap	Finial					Stair riser	
		Stair steps S		Stair steps C			
Newel post	Newel box	Stair steps S		Stair steps C		Stair step 1	

**TRIM Objects for ArchiCAD**

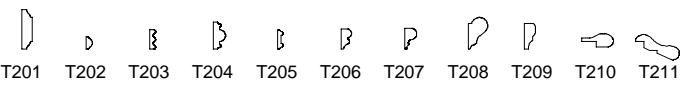
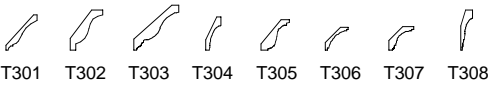
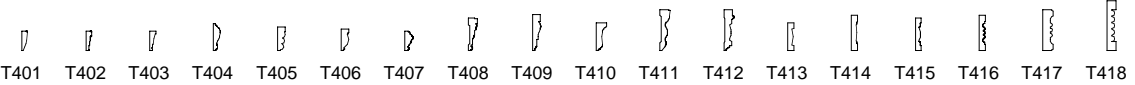
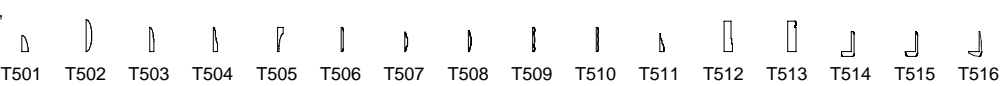

D<sup>3</sup> SmartParts™ © 1998 DIMENSIONS Design Group, Inc.

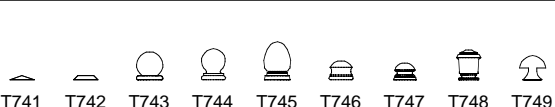

<b>Base Moulds</b>	
<b>Chair Rails, Picture Moulds</b>	
<b>Crown Moulds</b>	
<b>Casing</b>	
<b>Rounds, Corner, Edging</b>	
<b>Stair Handrail, Guardrail</b>	
<b>Finials, Caps</b>	

## TRIM Objects for ArchiCAD

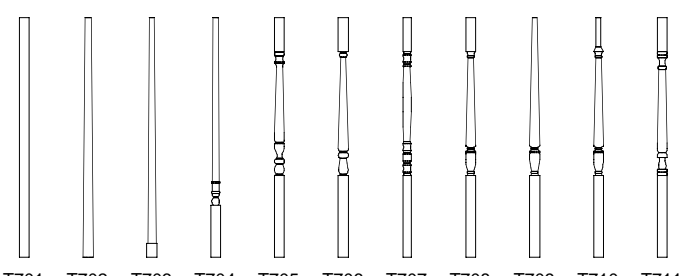
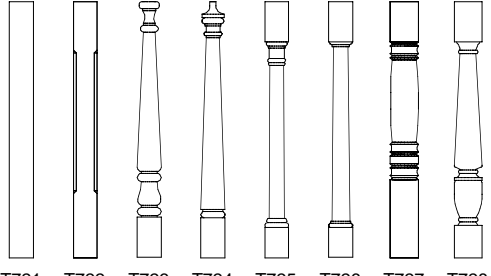
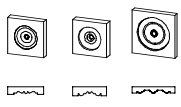
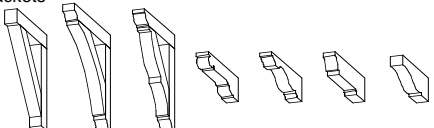
D<sup>3</sup> SmartParts™ © 1998 DIMENSIONS Design Group, Inc.

<b>Balusters</b>		<b>Newel posts</b>	
<b>Rosettes, Plinth blocks</b>		<b>Brackets</b>	
		<b>Dentils</b>	
<b>Panels, Wainscot</b>	